

## HIGH POWER DOWN LIGHT

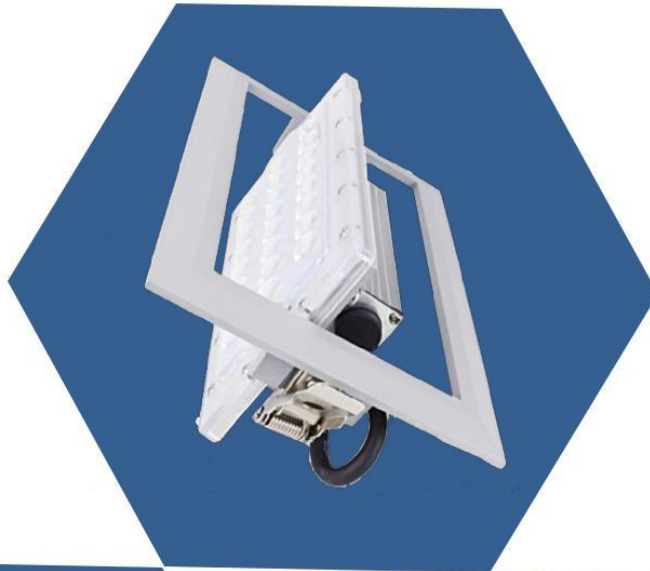

**PHILIPS**  
LUMILEDS



Elevata luminosità Bassi consumi Durata 5000 ore



ESEMPI DI APPLICAZIONE

*Vetrine*

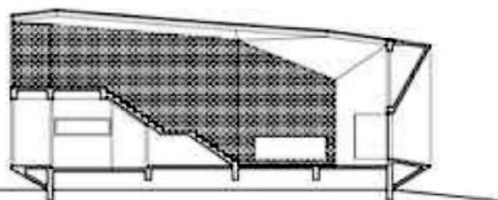
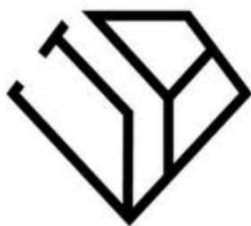

*Showroom*

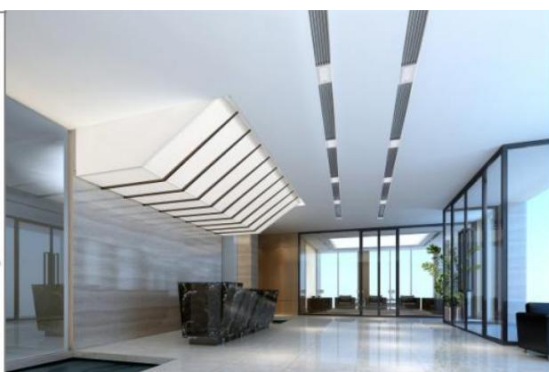

*Distributori  
di Carburante*

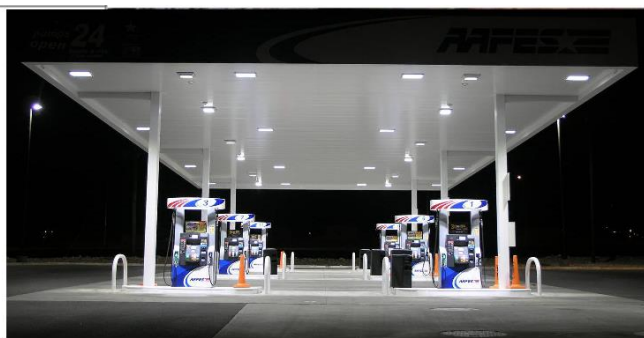

## DISTRIBUZIONE DELLA LUCE

### 30° curva di distribuzione

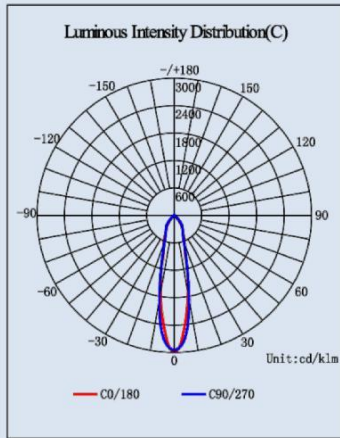

### 30° curva di illuminazione

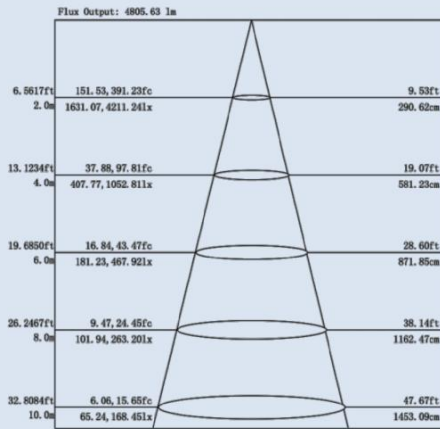

### 60° curva di distribuzione

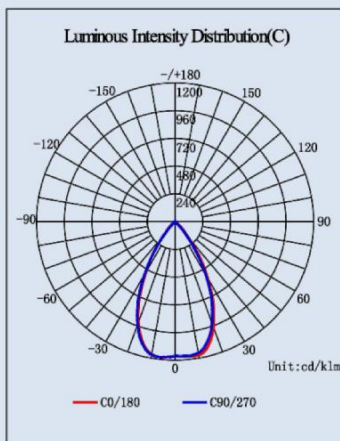

### 60° curva di illuminazione

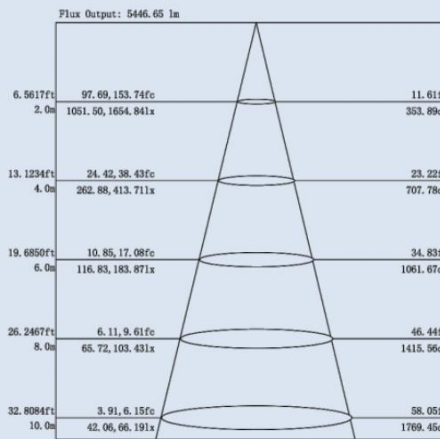

### 120° curva di distribuzione

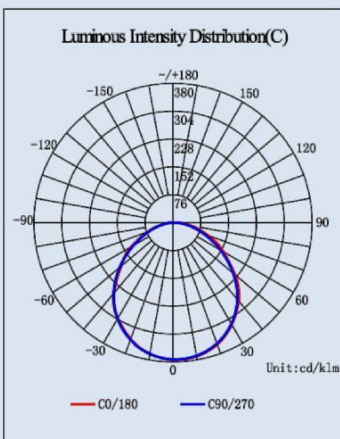

### 120° curva di illuminazione

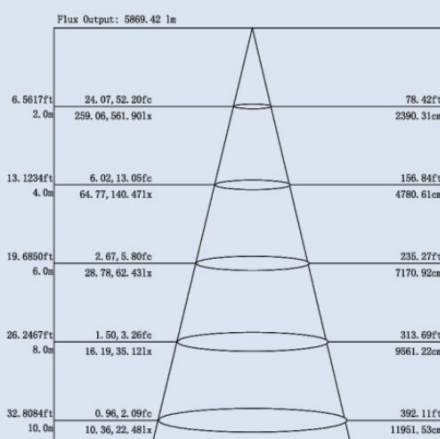

## TEST REPORT DLB3 30W (6000K)



WW 2700-3200K

NW 4000-4500K

PW 6000-6500K

curve of spectrum power distributing

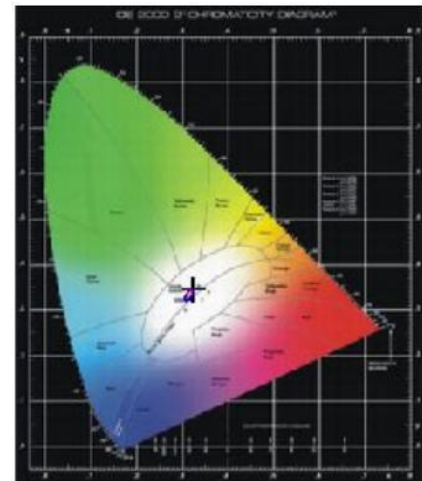
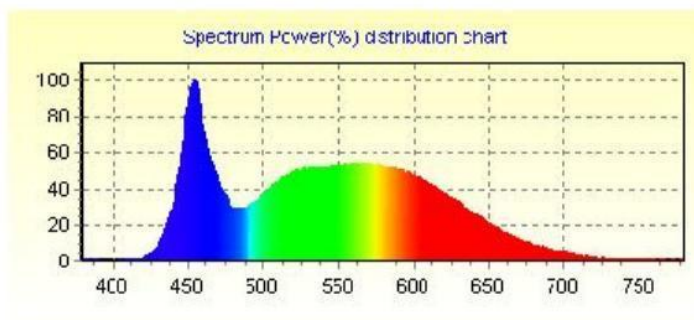

Spectrum		Electrical		
$\lambda$ (Peak):	453.6 nm	I (test):	159.000 mA	
$\lambda$ (Main):	509.8 nm	Vf:	222.000 V	
$\lambda$ (Centroid):	444.3 nm	$\Phi_v$ :	4217.7554 lm	
$\lambda$ (Center):	445.0 nm	Efficiency:	129.379 lm/w	
BandWidth:	25.0 nm	P:	32.6 W	
ColorTemp:	5976 K	PFC:	0.921	
CIE(x, y):	0.3215, 0.3486	R1:78.2	R2:87.7	R3:93.5
CIE(u, v):	0.1966, 0.3198	R4:78.6	R5:79.4	R6:84.2
Ra:	81.7	R7:87.0	R8:64.9	R9:-3.9
Purity:	0.037	R10:71.1	R11:83.6	R12:52.0
Light Power:	15053.4077 mw	R13:80.7	R14:96.6	R15:72.0



WATERPOOF



TEST TEMPERATURE ESTREME



## DIMENSIONI

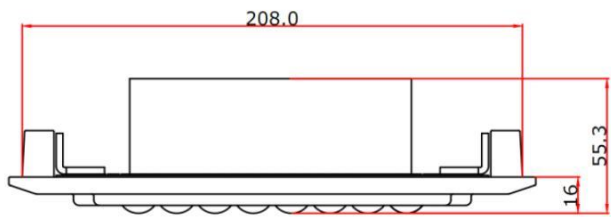
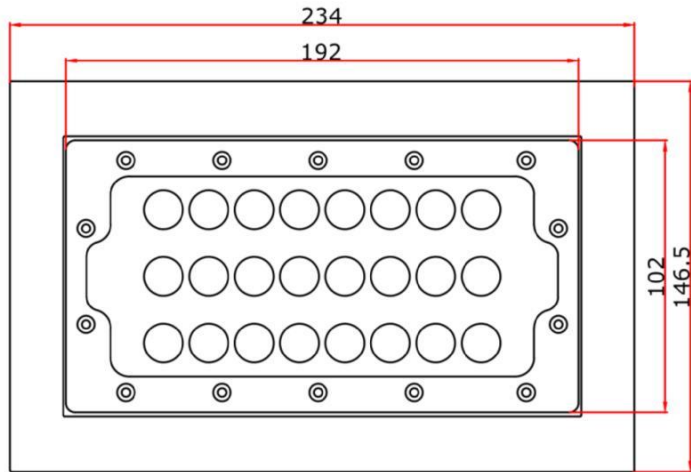

30W

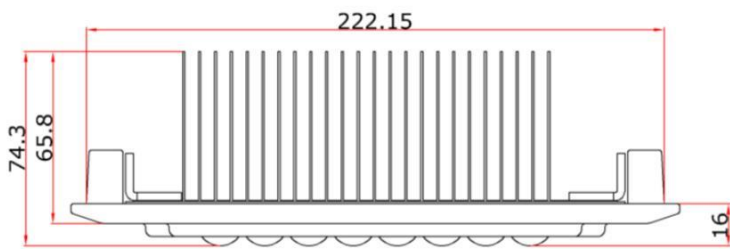
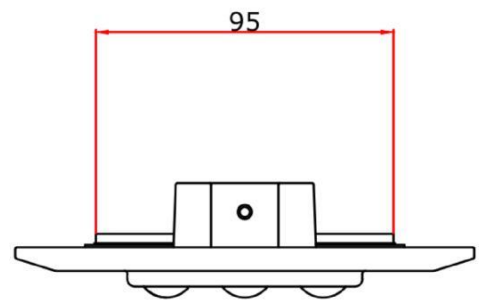

50W

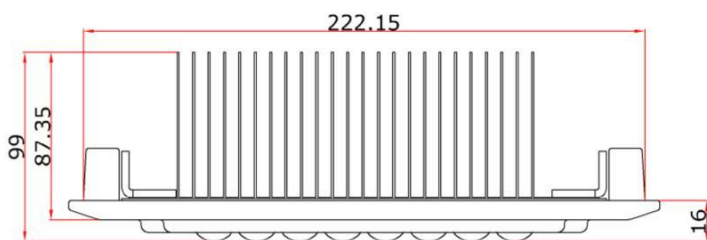
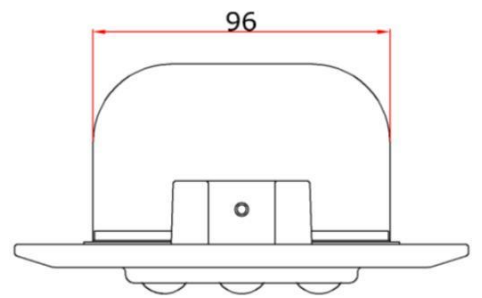

100W

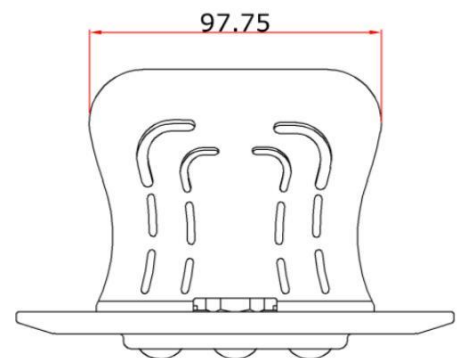

## SPECIFICHE

Parametri Elettrici	Voltaggio	AC90-2770/60HZ	Power Factor	> 0.95(220V)
	Tipo LED	Philips Lumileds	Flusso luminoso del LED	150-160LM/W
			Flusso luminoso della lampada	120LM/W $\pm$ 5%
	Durata	50.000 ore	CCT	2700-6500K
	Protezione IP	IP66	Temperatura di funzionamento	-40°C +60°C

## LISTINO PREZZI

Modello	Potenza	Quantità LED	Flusso luminoso	Angolo di emissione	Peso netto Kg	Prezzo Driver SunSeed	Prezzo Driver MeanWell
DLB3-30	30W	48PCS (Philips)	3300-3650LM	30°/60°/110°	1	€ 150,73	---
DLB3-50 DLB4-50	50W	72PCS (Philips)	5500-6100LM	30°/60°/110°/X-135°Y-65°	1,3	€ 187,85	€ 299,50
DLB3-100 DLB4-100	100W	168PCS (Philips)	11500-12100LM	30°/60°/120°	1,7	€ 372,92	€ 476,87

Prezzi IVA esclusa